

# Atmospheric Greenhouse Gas Measurements at Trainou Tower

M. Schmidt, M. Ramonet, C. Messenger, Camille Yver,  
Mathilde Grand, Claire Kaiser, Cyrille V.  
C. Valant, B. Wastine, O. Cloué and P. Ciais

*Laboratoire des Sciences du Climat et de l'Environnement (UMR 1572 CNRS-  
CEA)*



# RAMCES measurement network

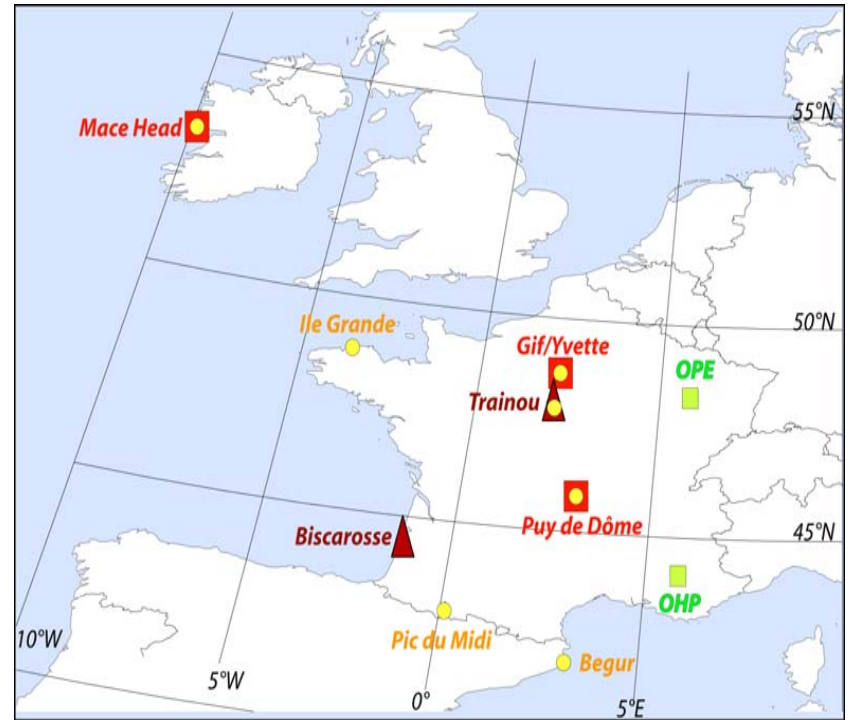
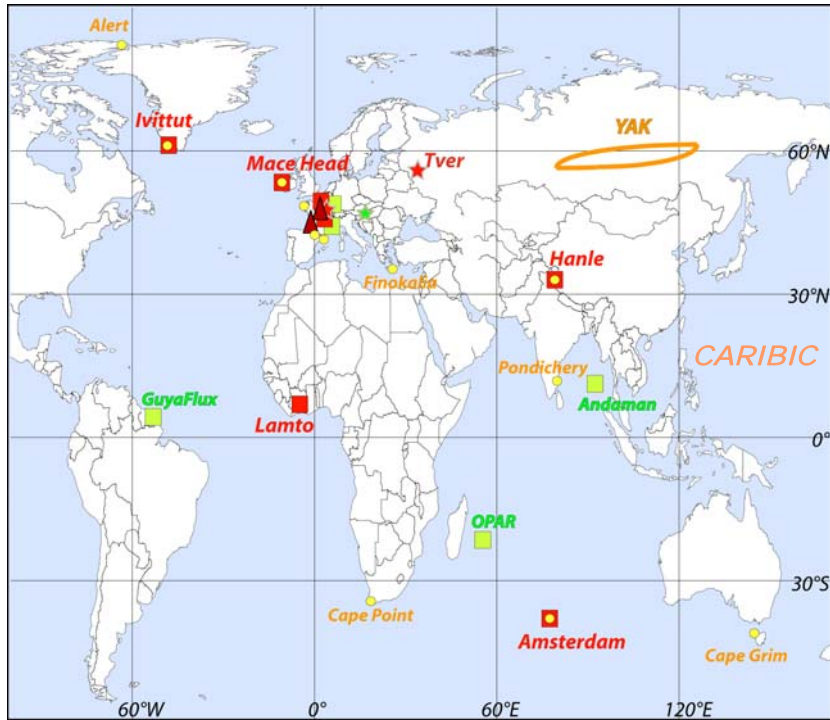

- **Monitoring station**
- ▲ **Tower site**
- **Weekly Flask sampling site**
- **cooperative sites**
- **Airborne Campaign**



## CO<sub>2</sub>

CARIBOU	TRN	HLE	IVI	GIF
Licor	MHD	PUY		
Siemens	AMS			
LOFLO	AMS	GIF		
Picarro	LTO	GIF	BIS	GUY
AIRCOA	GIF			
Condor	ORL	YAK	CAR	

## CH<sub>4</sub>

GC Agilent	GIF	TRN	PUY
Picarro	LTO	GIF	BIS

## N<sub>2</sub>O

GC Agilent	GIF	TRN	PUY
------------	-----	-----	-----

## SF<sub>6</sub>

GC Agilent	GIF	TRN	PUY
------------	-----	-----	-----

## <sup>13</sup>CO<sub>2</sub>

Mat252	GIF
--------	-----

## CO/H<sub>2</sub>

GC PP1	GIF	TRN
--------	-----	-----

## Radon

Rn-Aerosol	AMS	MHD	PUY	GIF
Rn-Gas	TRN			

## O<sub>2</sub>

Paramag.	IVI
----------	-----

**26 Trace gas in-situ analyser at 12 stations (surface +airborne)**

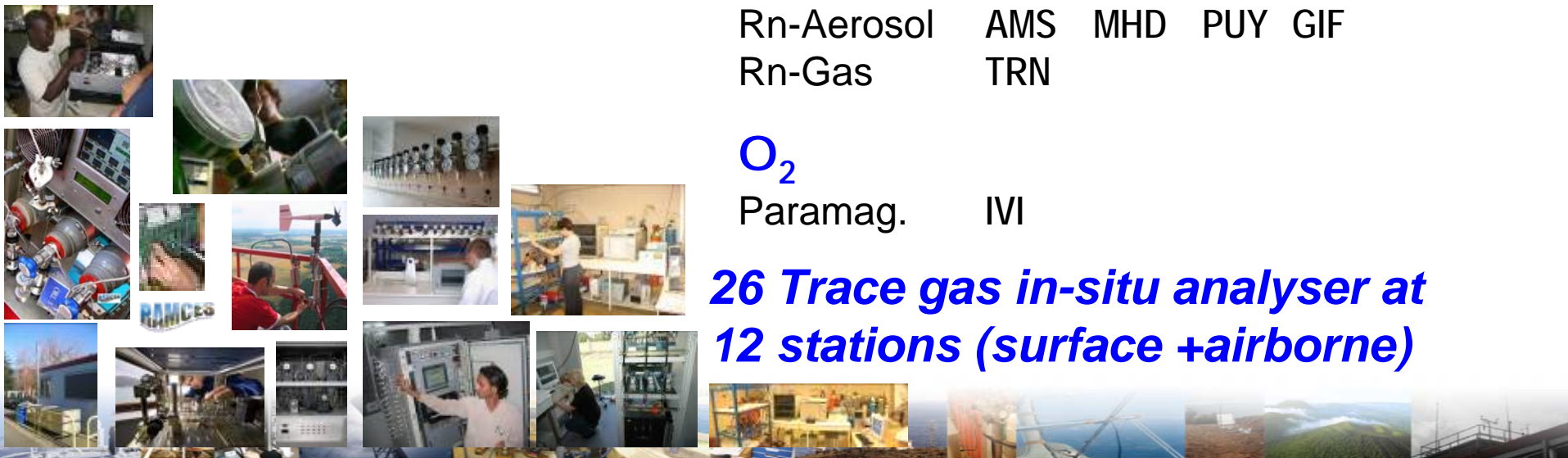

# Flasks analyzing facilities

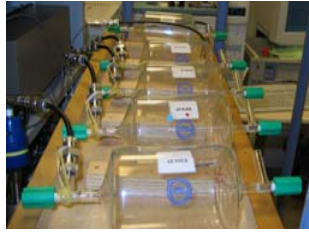

Flask sampling: about 2200  
flasks/year  
12 surface site  
5 airborne sites  
ICP



Two GC in series HP-6890 and PP1  
FID: CO<sub>2</sub> and CH<sub>4</sub>  
ECD: N<sub>2</sub>O and SF<sub>6</sub>  
PP1: CO and H<sub>2</sub>



MAT 252  
Since Feb 2005 new trapping box  
(in cooperation with Willi Brand MPI Jena)



# Vertical profiles: RAMCES » Super... Orleans forest/Trainou



In-situ: CO<sub>2</sub> 1-2 flights /months (100-3000m)  
Flasks: CO<sub>2</sub>, CH<sub>4</sub>, N<sub>2</sub>O, SF<sub>6</sub>, CO, isotopes CO<sub>2</sub>

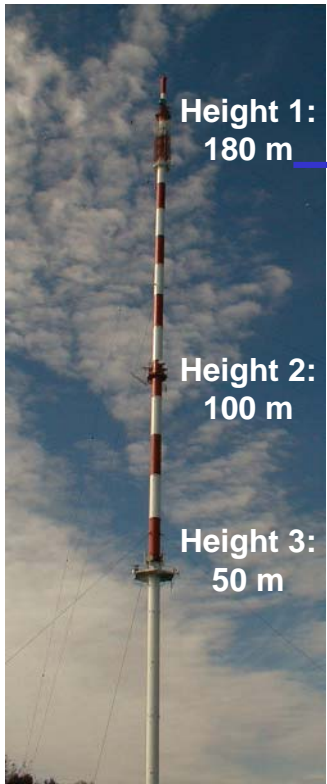
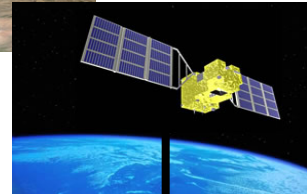

In-situ: CO<sub>2</sub>, CH<sub>4</sub>, N<sub>2</sub>O, SF<sub>6</sub>, CO, H<sub>2</sub>, <sup>222</sup>Rn  
meteorol. data

Flasks: CO<sub>2</sub>, CH<sub>4</sub>, N<sub>2</sub>O, SF<sub>6</sub>, CO, H<sub>2</sub>, isotopes CO<sub>2</sub>  
<sup>14</sup>CO<sub>2</sub> sampling

CO<sub>2</sub>  
column density  
from  
space & ground

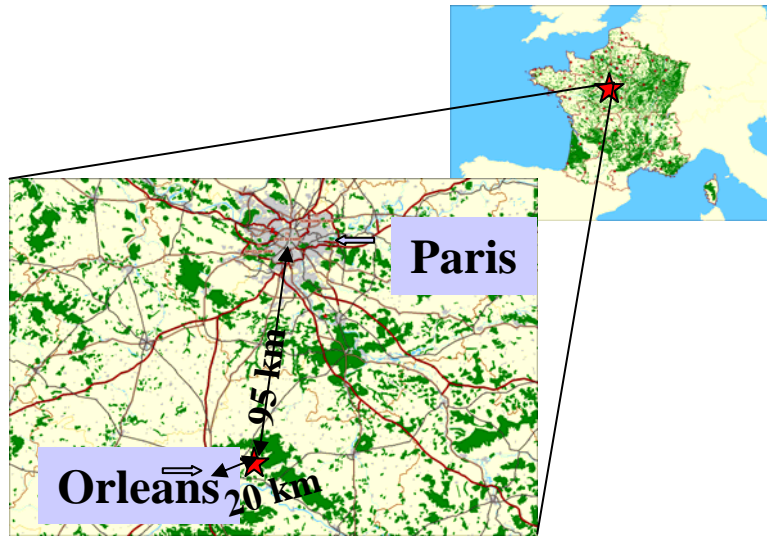

FTIR Trainou: GEOMON'09



# Trainou Tower : installation



height (m)	equipments
180	3 lines +Radon, meteo
100	1 sampling line
50	2 sampling line
0	meteo Instruments



ADSL



# Distribution of air

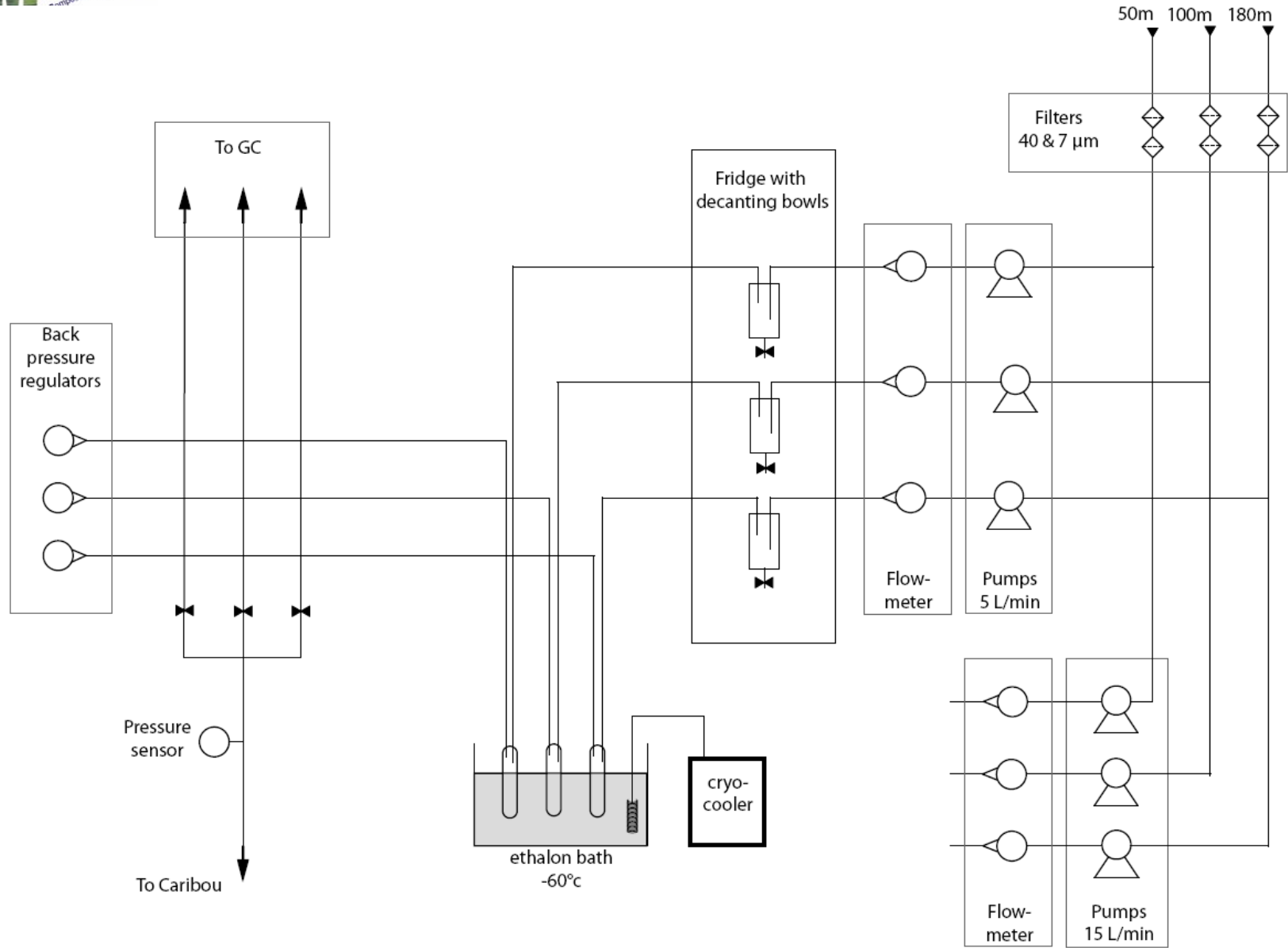

# Instrumentation at Trainou station



CO<sub>2</sub>, CH<sub>4</sub>, N<sub>2</sub>O, SF<sub>6</sub>  
 CO + H<sub>2</sub>  
 CO<sub>2</sub>

GC HP6890  
 PP1  
 CARIBOU (Licor 6252)

Radon-222

ANSTO

Flask sampler

LSCE

Integrated 14CO<sub>2</sub> sampler

IUP Heidelberg





# QC/QA : Target gas repeatability

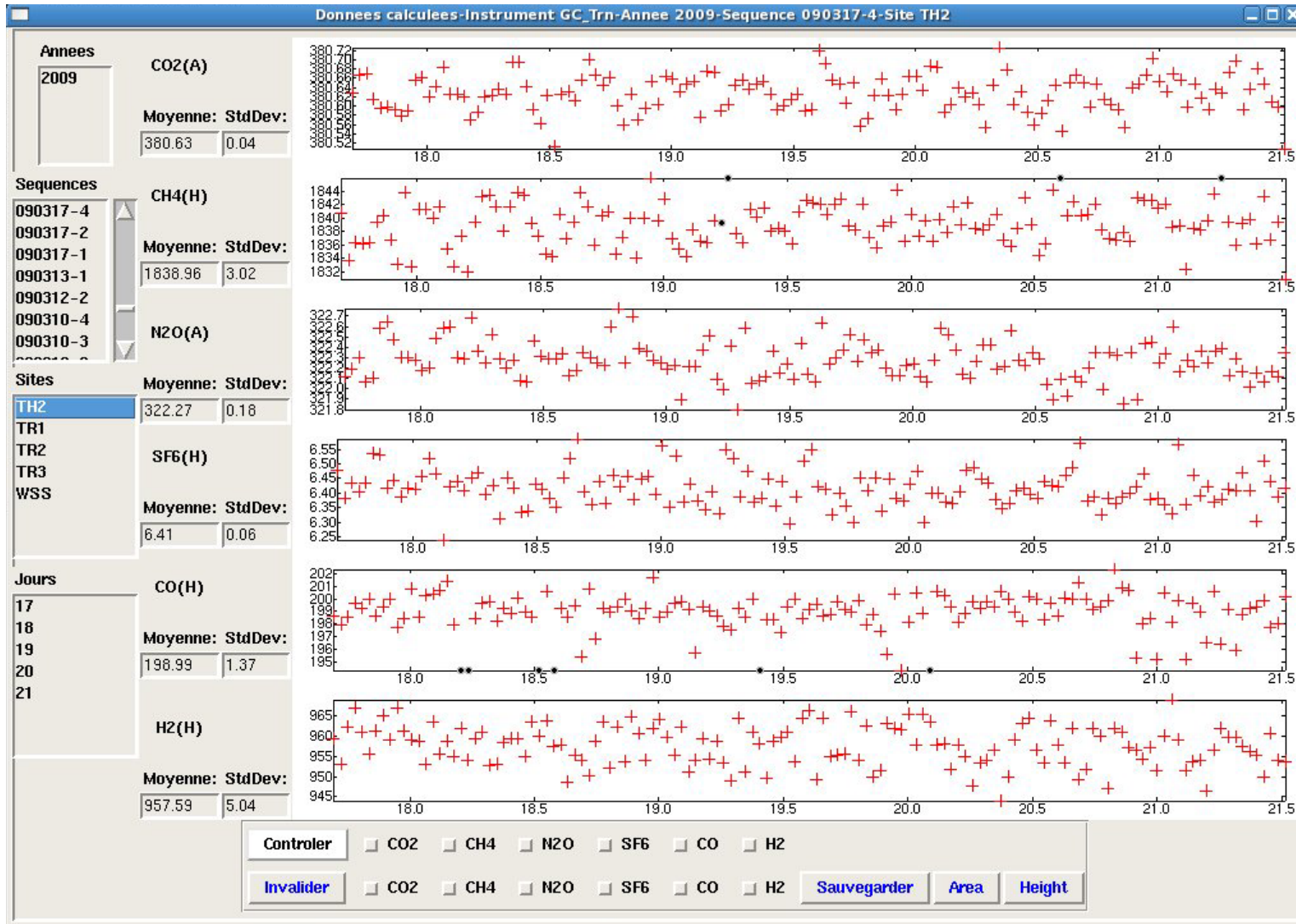

CO2  
±0.04 ppm

CH4  
±3.0 ppb

N2O  
±0.18 ppb

SF6  
±0.06 ppt

CO  
±1.4 ppb

H2  
±5 ppb



# Target gas analysis

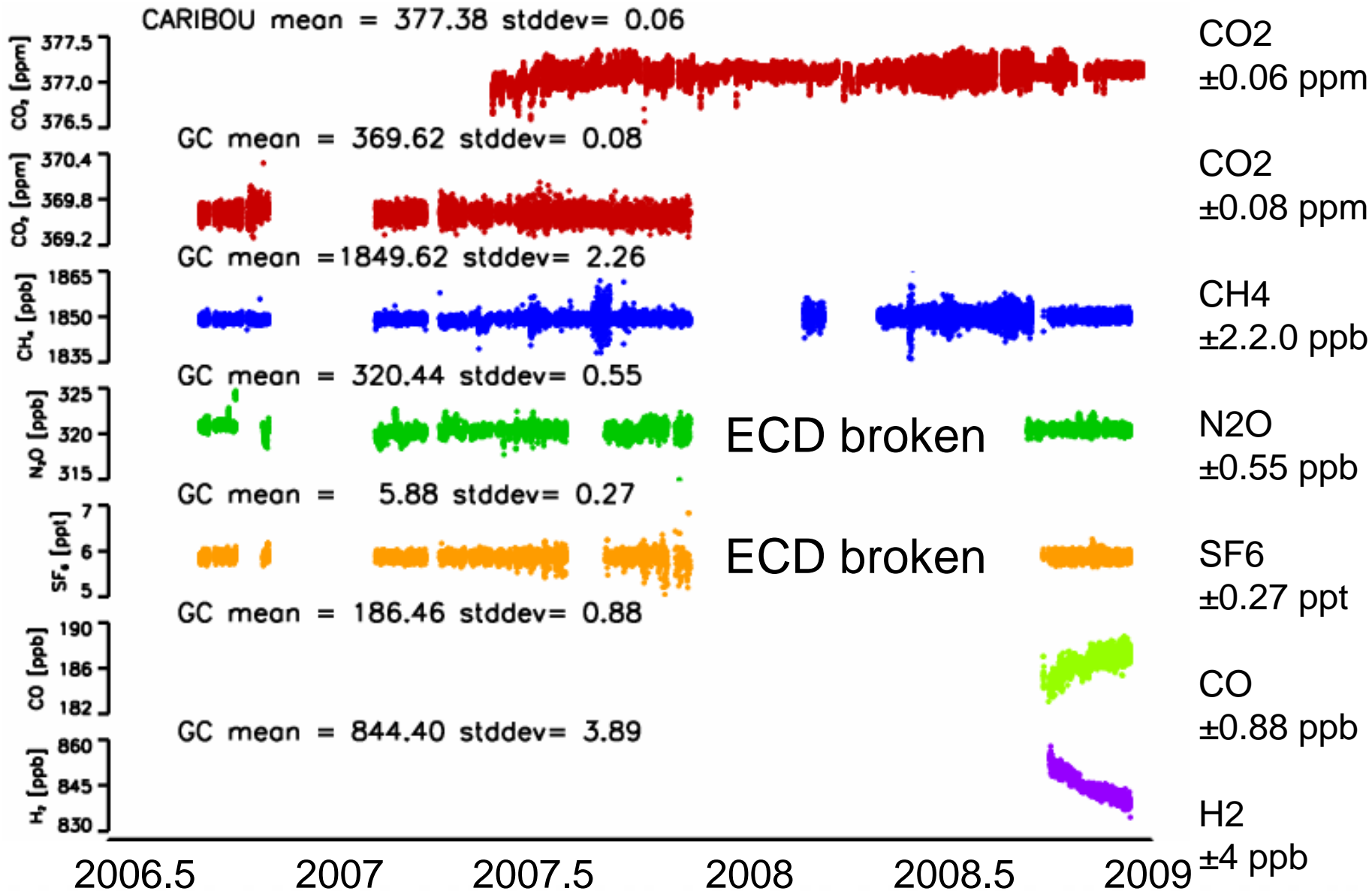

# QC/QA : Ambient air

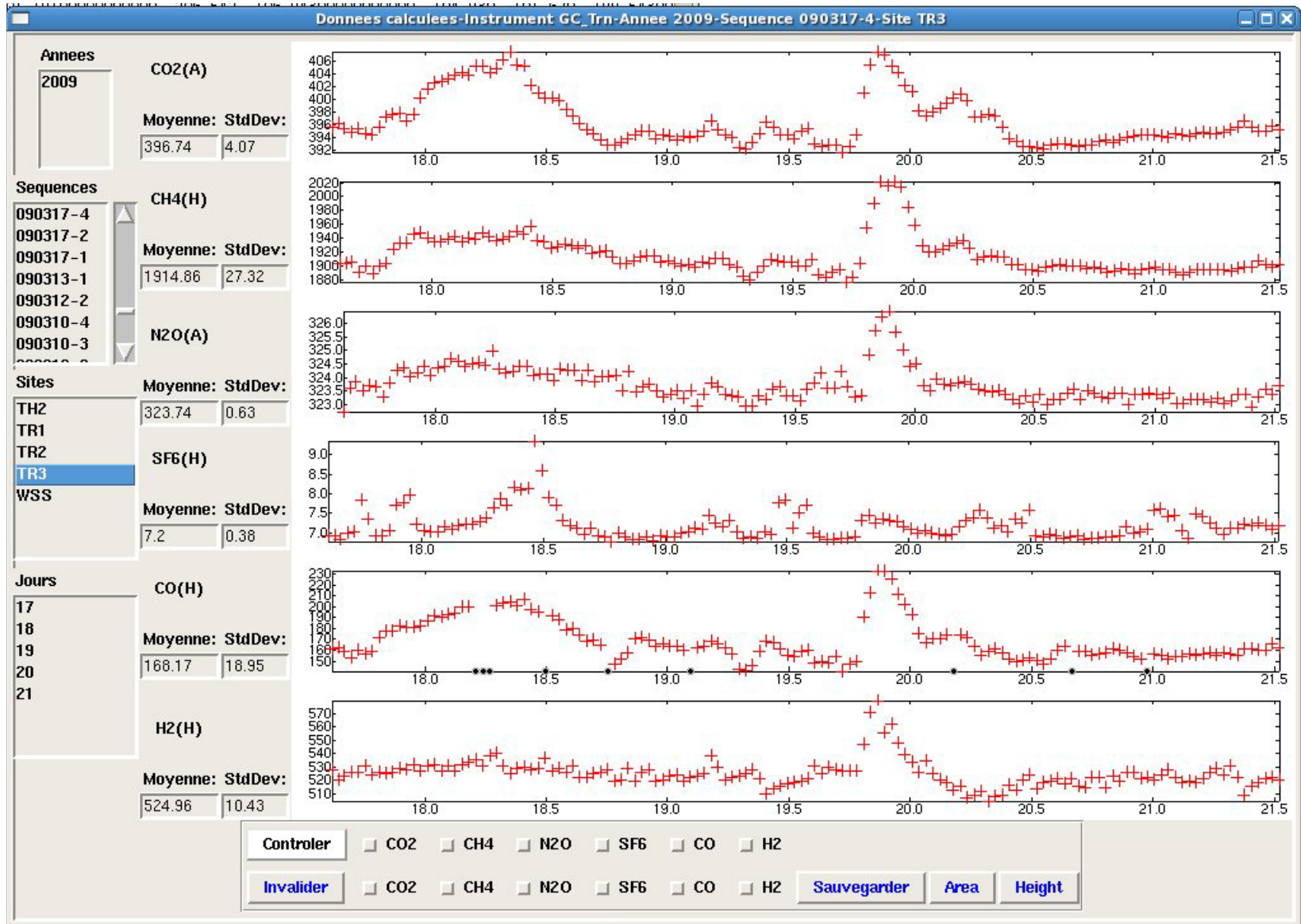

# QC/QA : Ambient air

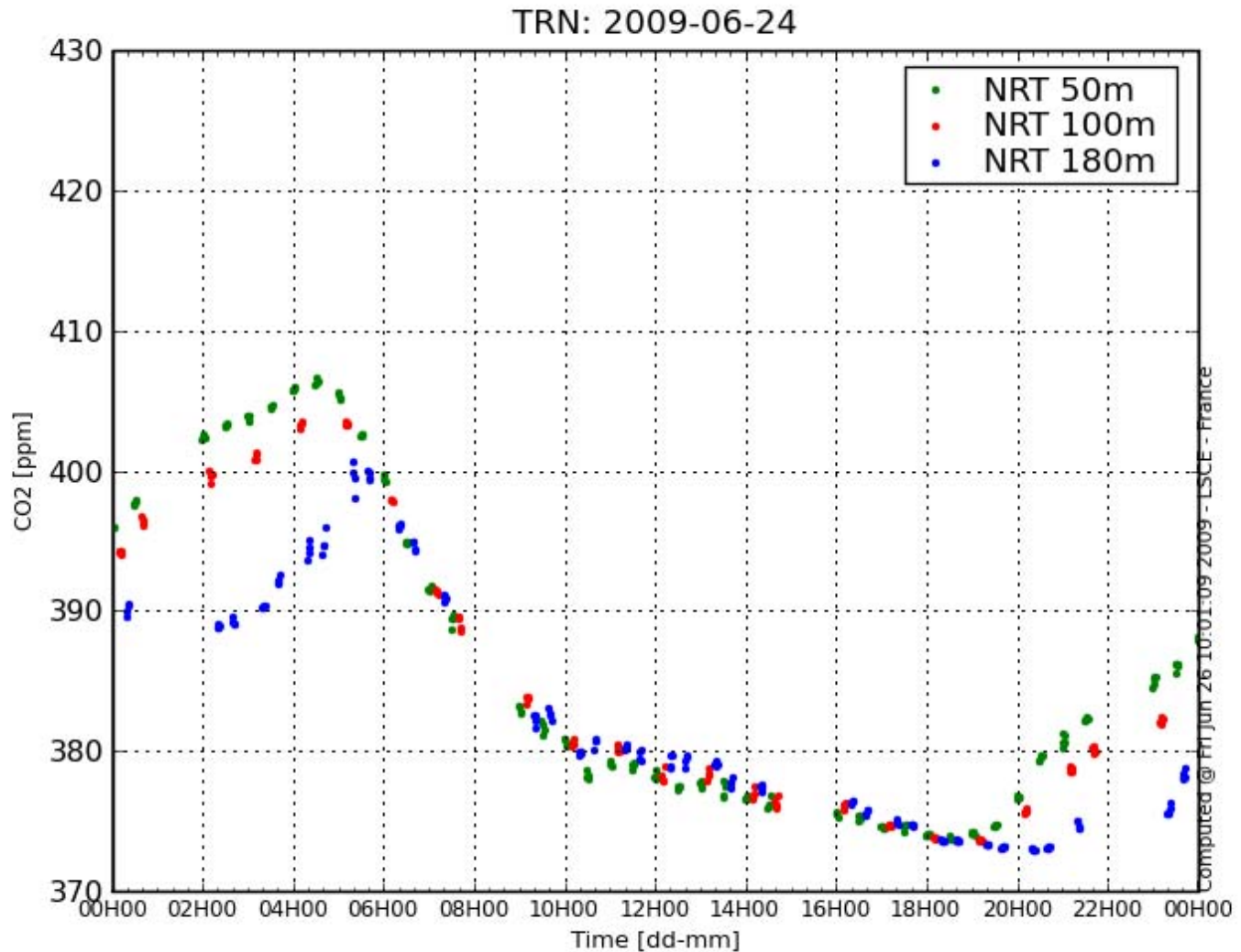

# TR3: 180m level

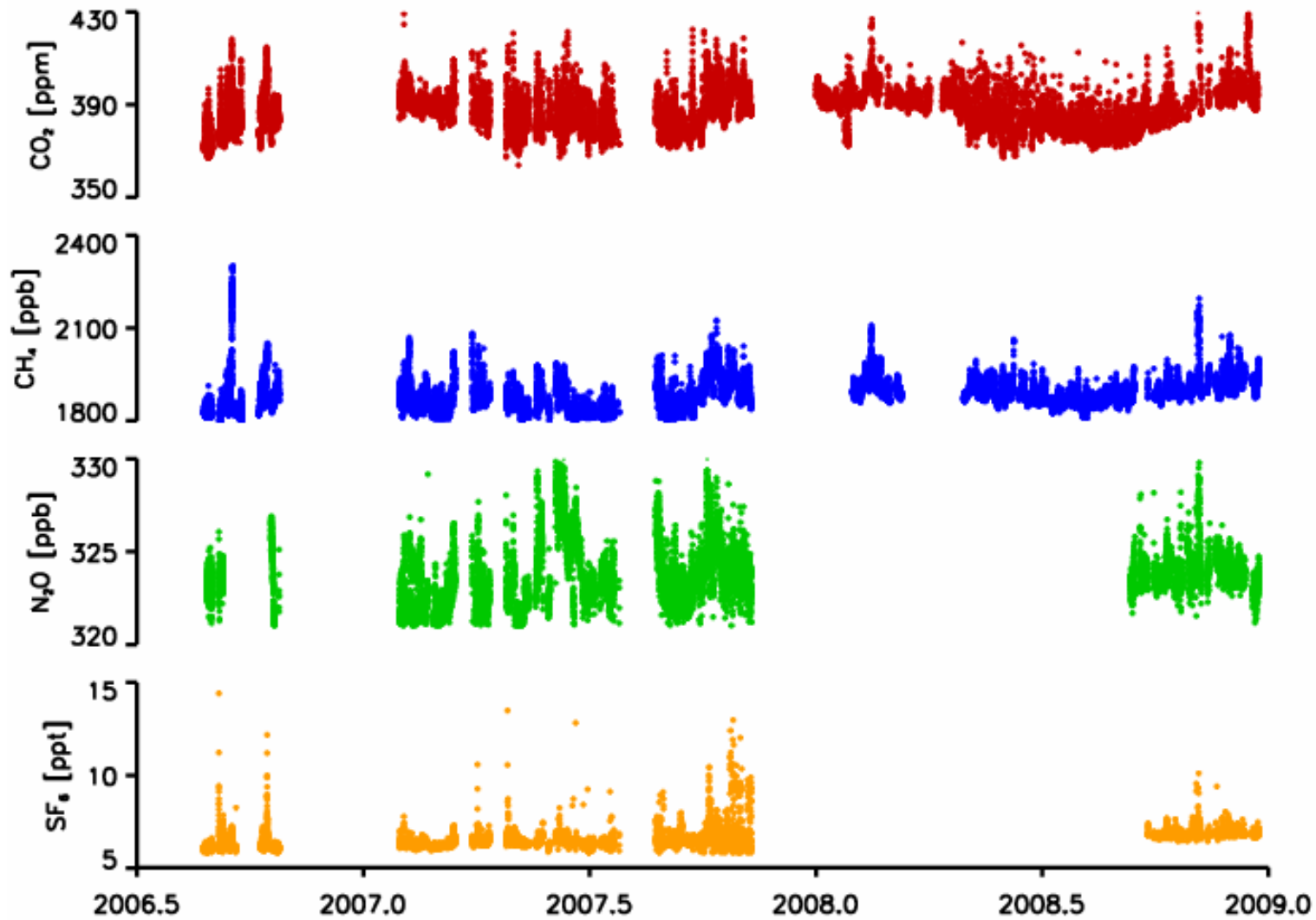



# One week in August 2009

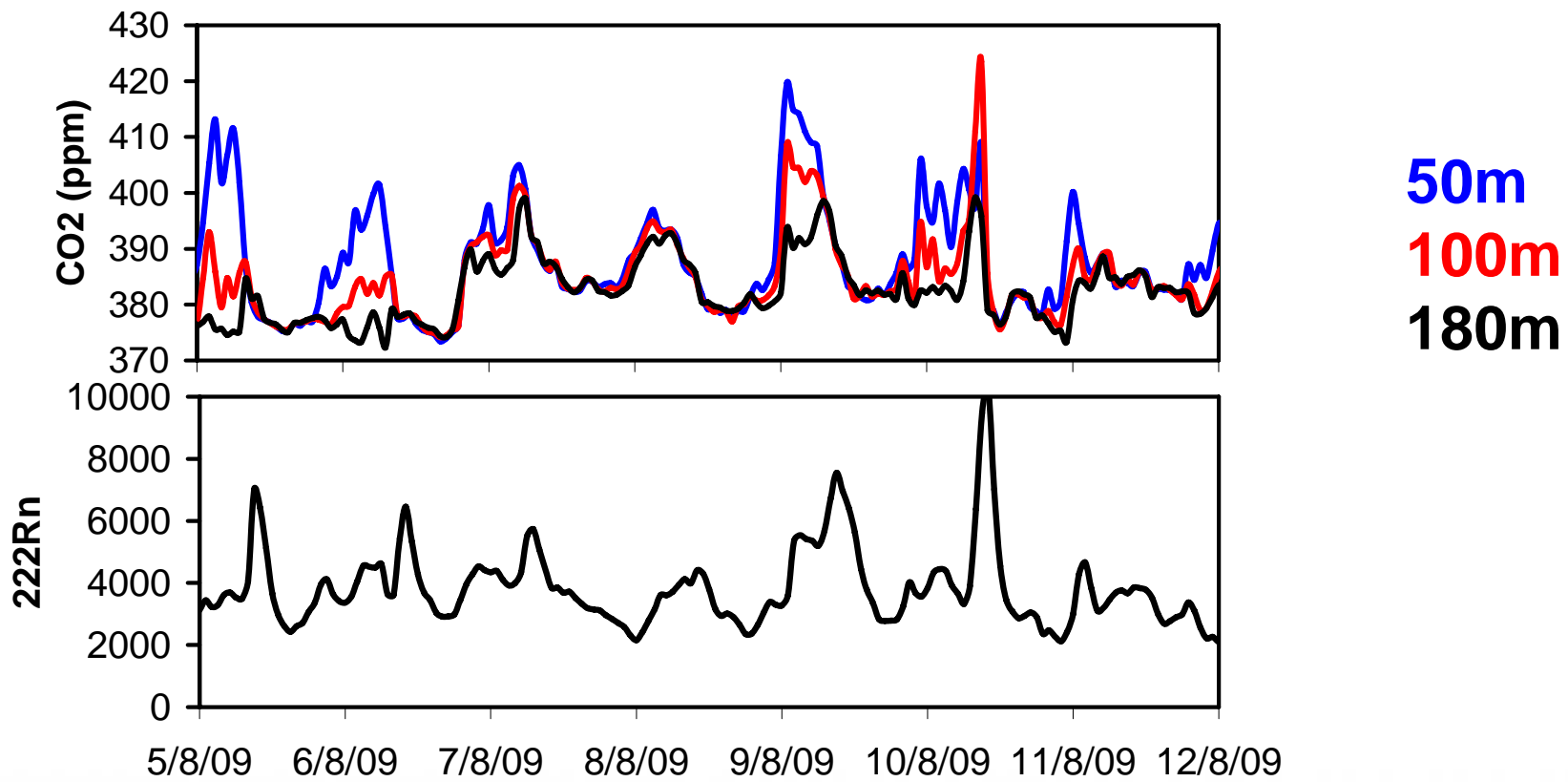

# One week in August 2009

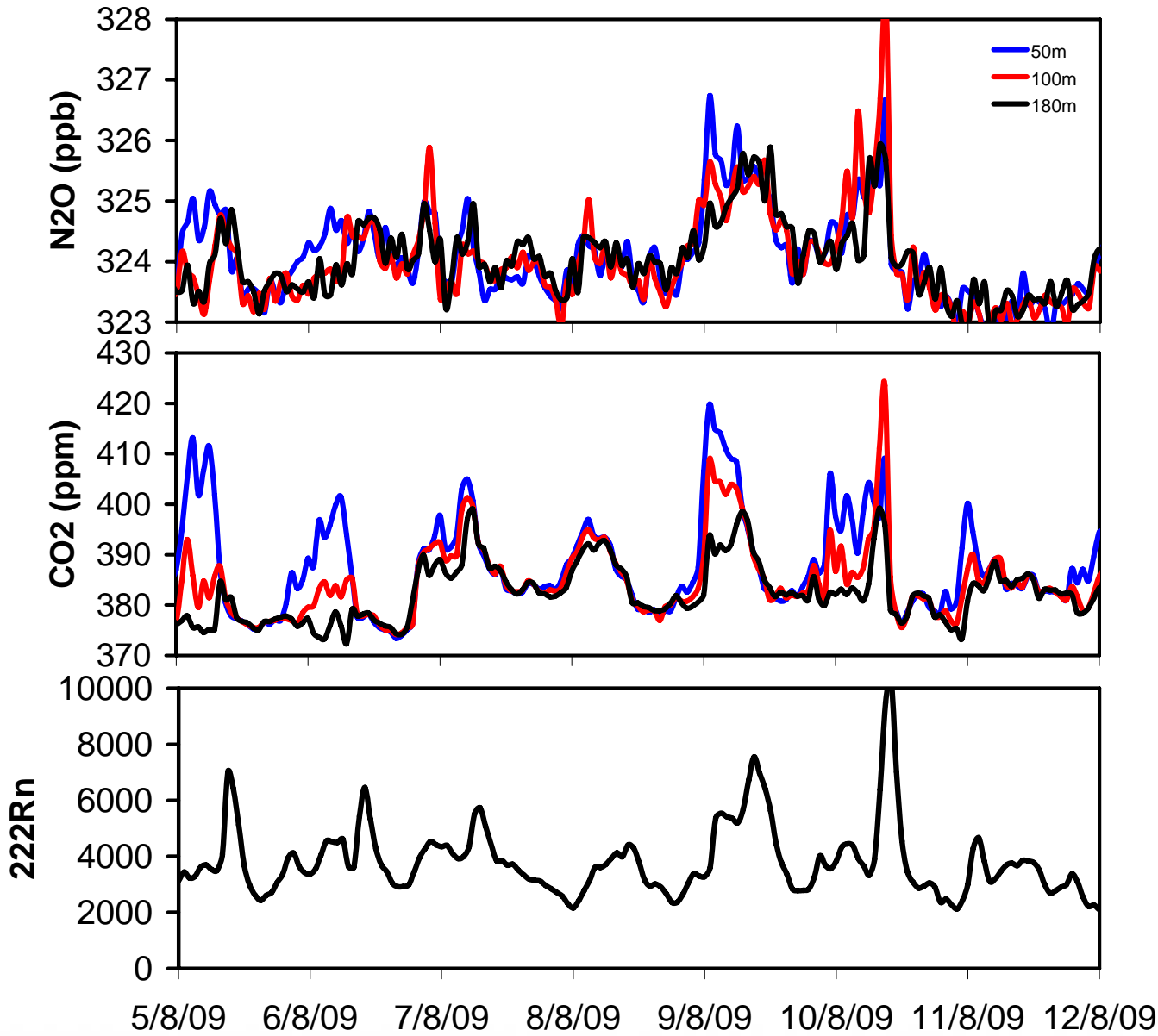

**50m**  
**100m**  
**180m**





# Vertical profiles

## 5-11/August 2009

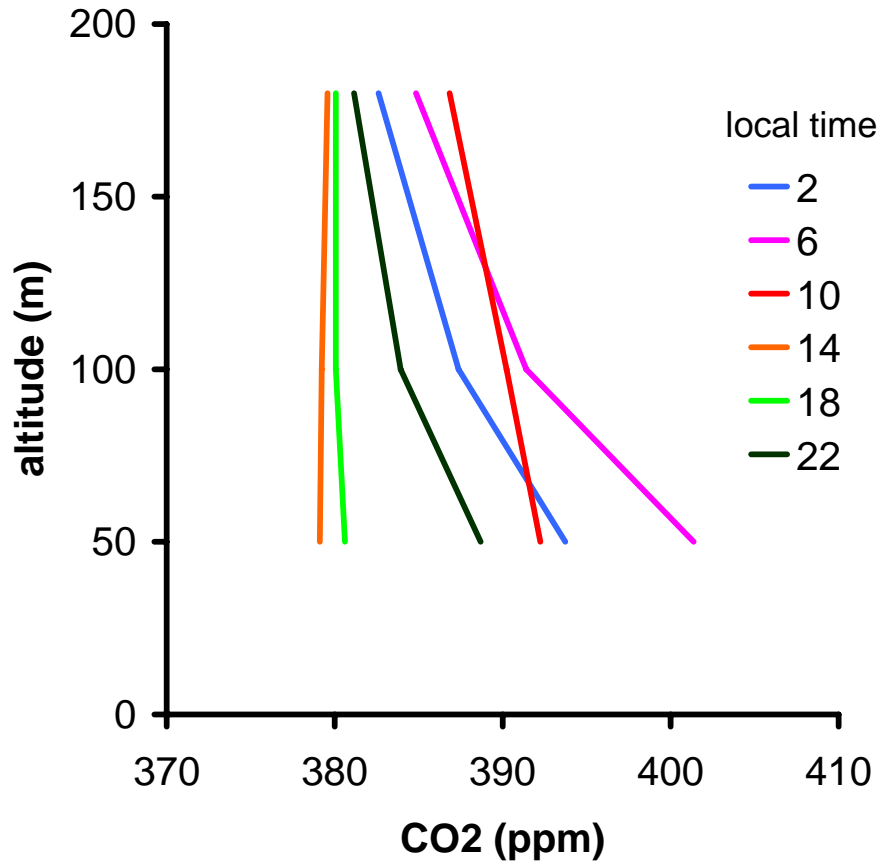

# Vertical profiles

## 5-11/August 2009

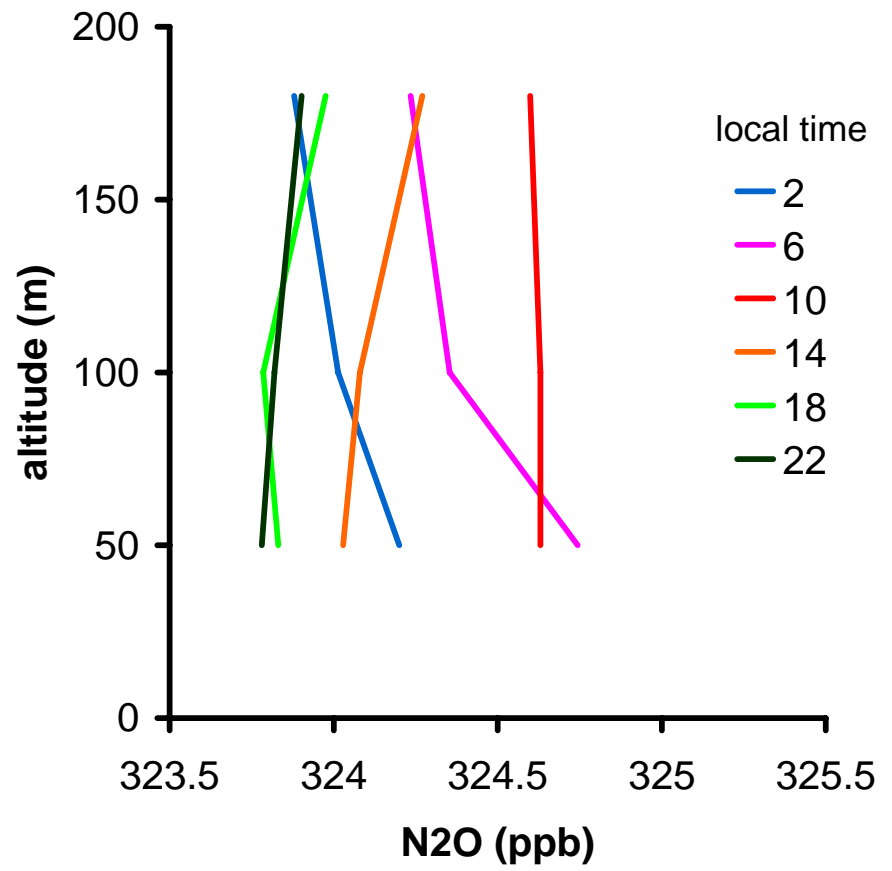
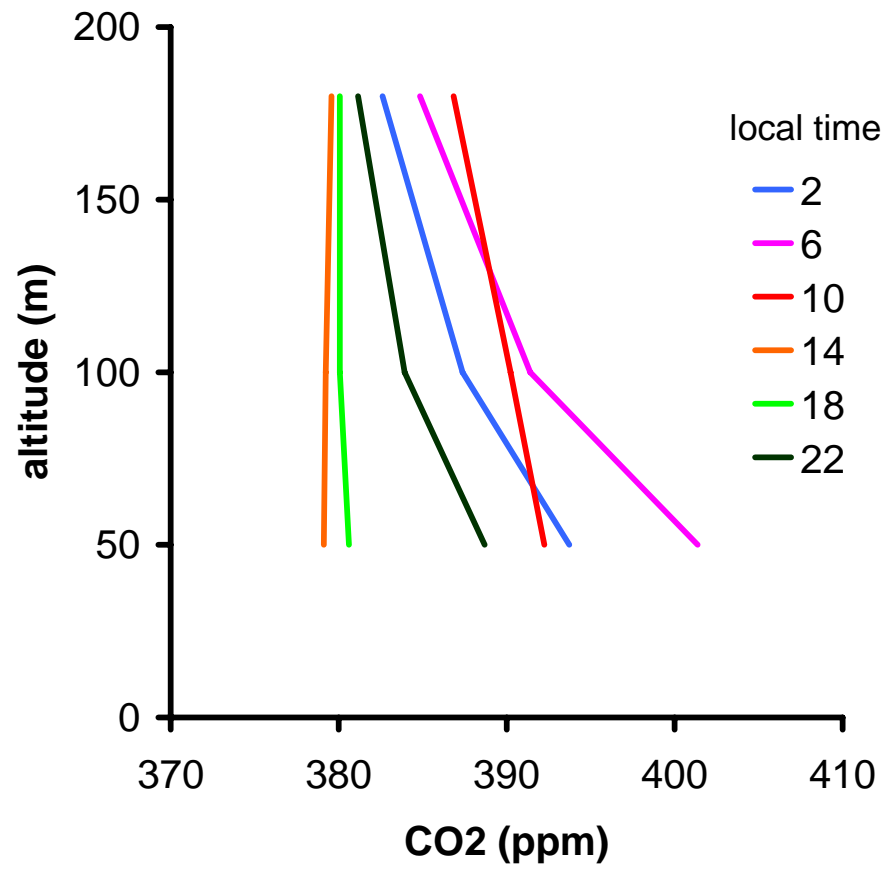

- Installation of insitu  $CO_2$ ,  $CH_4$ ,  $N_2O$ ,  $SF_6$  and flask sampler (summer 2006)
- $^{14}CO_2$  sampler in cooperation with UHEI spring 2008
- $H_2/CO$  GC in summer 2008 (in-situ and flasks)
- $^{222}Rn$  gas analyser (Fall 2009)
- FTIR at Trainou Tower (August 2009) University Bremen
  
- More difficulties as expected to run a GC system fully remote at a station.
  
- Transfer of the raw data to the database, automatization of concentration calculation and presentation of the near real-time data, help to identifying measurement problems.

